



Caractéristiques

- Boîtier robuste en acier inoxydable pour des conditions d'environnement sévères
- Résistance à l'abrasion et aux substances chimiques grâce à la cellule de mesure céramique
- Programmation externe du zéro et du gain avec le FlexProgrammer 9701

Applications

- Pneumatique
- Gaz médicaux
- Automatisation industrielle
- CVC
- Véhicules agricoles
- Energie

Données techniques

Principe de mesure	Céramique couche épaisse
Plages de mesure	-1 ... 0 bar à 0 ... 600 bar
Type de pression	Relative / Absolue
Exactitude (20 °C) (linéarité, hystérésis, répétabilité, erreur de l'échelle et du zéro, selon le réglage du point limite)	≤ 0,7% EM ≤ 0,5% EM
Turn down	2:1
Réglage de l'échelle de mesure	[Turn-Down] * [Exactitude] FS
Dérive thermique du zéro	≤ ± 0,08% EM/10 K
Dérive thermique du gain	≤ ± 0,08% EM/10 K
Stabilité annuelle	0,2% EM / an
Temps de réponse (10 ... 90%)	≤ 5 ms
Raccords de pression	Voir page 3

Environnement

Température	
Stockage	-40 ... + 100°C
Plage compensée	-20 ... + 60°C
Fluides	
NBR	-30 ... + 100°C
EPDM	-40 ... + 125°C
FKM (Viton®)	-20 ... + 125°C
Environnement	-20 ... + 85°C
Indice de protection	IP65 (EN 60529) jusqu'à IP67 selon le raccordement électrique
Vibration IEC60068-2-6	1,5 mm p-p (10 – 55 Hz), 10 g (55 Hz – 2 KHz) 10 cycles en 2,5 h par axe

Shock IEC60068-2-27	50 g/11 ms 100 g/6 ms 3 x Imp. /axe et direction
Bump IEC60068-2-27	100 g/2 ms 4000 x Imp./axe et direction
Random IEC60068-2-64	0,1 g ² /Hz (20 Hz – 1 KHz) 30 min par axe (>10 g RMS)

Caractéristiques électriques

Signal de sortie / alimentation électrique	4 ... 20 mA / 8 ... 32 Vcc 0...10 V / 13 ... 32 Vcc
Impédance en charge	
Courant de sortie	$R_{\Omega} = (U_{Aim} - 8 V) / 20 mA$
Tension de sortie	> 5 KΩ
Résistance d'isolation	>100 MΩ à 500 Vcc
Raccordements électriques	Voir page 3

Matériaux

Raccord	Acier inoxydable 1.4404 AISI 316L
Boîtier	Acier inoxydable 1.4301 AISI 304
Membrane	Céramique (96% Al ₂ O ₃)
Étanchéité	NBR, EPDM, FKM (Viton®)
Câble	PUR

Approbatons

Conformité CE	Directive CEM 2004/108/CE selon EN 61000-6-2, EN 61000-6-3, EN 61326-1 (Tab.2) Directive Pression 97/23/CE
---------------	---

Étendues de mesure

	Pression en bar						
Plage de pression	-1 ... 0	-1 ... 1,5	-1 ... 3	-1 ... 5	-1 ... 9	-1 ... 15	-1 ... 24
	-1 ... 0,6	0 ... 2,5	0 ... 4	0 ... 6	0 ... 10	0 ... 16	0 ... 25
	0 ... 1						
	0 ... 1,6						
Surpression	2	4	8	12	20	32	50
Pression d'éclatement	3	7	12	18	30	48	75

	Pression en bar						
Plage de pression	-1 ... 39	0 ... 60	0 ... 100	0 ... 160	0 ... 250	0 ... 400	0 ... 600
	0 ... 40						
Surpression	80	120	200	320	360	600	800
Pression d'éclatement	120	180	300	480	480	800	1000

Raccordements électriques

Signal en 4...20 mA / Signal en 0...10V

M12
4-broches

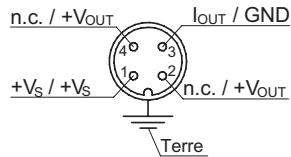

Connecteur
DIN 43650

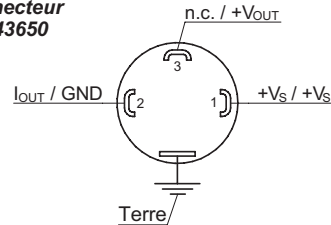

Sortie
câble

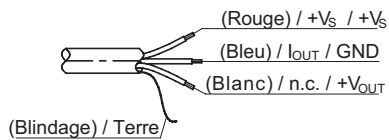

Dimensions (mm)

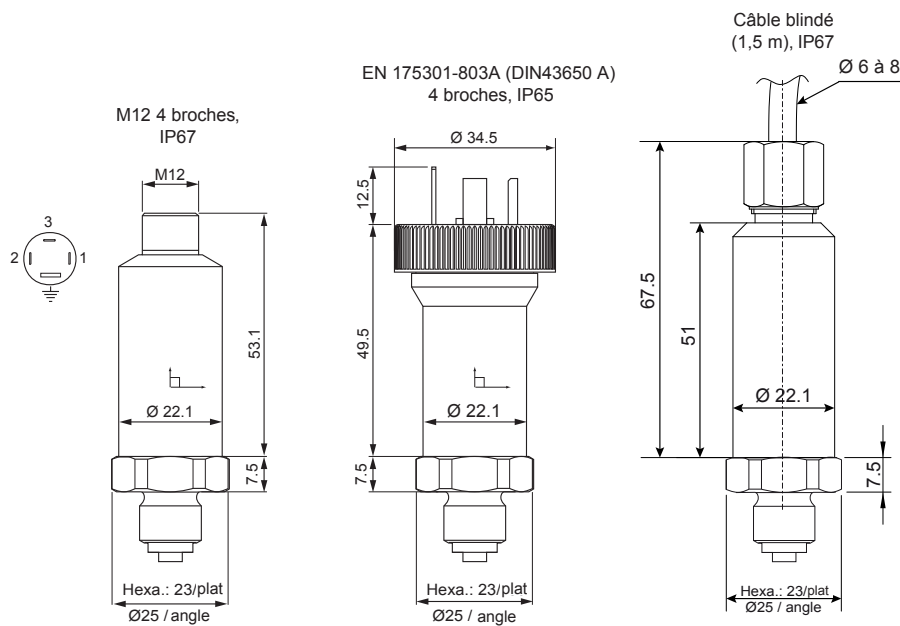

Raccords hydrauliques

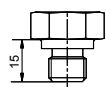

G 1/4 DIN 3852-E

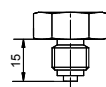

G 1/4 EN837

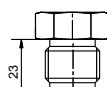

G 1/2 EN837

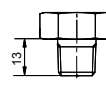

1/4 NPT

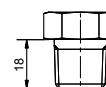

1/2 NPT

Codification PBSN

	PBSN	-	1	.	2	.	xxx	.	x	.	xx	.	xx	.	xx	.	x	.	x
Modèle	Transmetteur de pression industriel																		
	PBSN	-																	
Matériau	Acier inoxydable 1.4301 AISI 304																		
			1																
Exactitude	0,7% EM																		
																			2
	0,5% EM P > 1 bar																		
																			3
Étendue de mesure en bar	-1...0 Uniquement type de pression relative B59																		
	-1...0,6 Uniquement type de pression relative B72																		
	-1...1,5 Uniquement type de pression relative B74																		
	-1...3 Uniquement type de pression relative B76																		
	-1...5 Uniquement type de pression relative B77																		
	-1...9 Uniquement type de pression relative B79																		
	-1...15 Uniquement type de pression relative B81																		
	-1...24 Uniquement type de pression relative B82																		
	-1...39 Uniquement type de pression relative B1L																		
	0...1 B15																		
	0...1,6 B16																		
	0...2,5 B18																		
	0...4 B19																		
	0...6 B20																		
	0...10 B22																		
	0...16 B24																		
	0...25 B26																		
	0...40 B27																		
	0...60 B29																		
	0...100 B31																		
	0...160 B33																		
	0...250 B35																		
	0...400 B38																		
	0...600 B39																		
Type de pression	Absolue A																		
	Relative R																		
Signal de sortie	4...20mA A1																		
	0...10V A2																		
Raccordements électriques	M12, 4 broches 14																		
	DIN 43650, 4 broches 44																		
	Câble blindé (1,5 m) 53																		
Raccords de pression	G $\frac{1}{4}$ EN 837 02																		
	G $\frac{1}{2}$ EN 837 03																		
	$\frac{1}{4}$ NPT 04																		
	$\frac{1}{2}$ NPT 05																		
	G $\frac{1}{4}$ DIN 3852 06																		
Matériau pour raccords de process	Acier inoxydable 1.4404 AISI 316L 2																		
Étanchéité	NBR 1																		
	EPDM 2																		
	FKM (Viton®) 3																		